

DRYER MASTER



DM510

Computerized Grain Drying Control System

COMMISSIONING GUIDE

Dryer Master DM510

Commissioning Guide

©Dryer Moisture Systems Inc.
115 Ardelt Ave. Bldg#2 • Kitchener, Ontario
Phone 519.725.4700 • Fax 519.885.4300
USA & Canada – Toll Free – 1-800-265-2757
E-mail: info@dryermaster.com

Reminder

Remember to register your DM510 at dryermaster.com
**Simply by registering your new DM510 you can automatically
extend your warranty from 1 year to 2 years.**

February 28, 2015
January 15, 2016
January 31, 2017
March 30, 2018
January 10, 2019
January 14, 2020

What is in this guide

This Commissioning Guide explains how to customize your DM510 system to your particular dryer.

Before following the instructions in this guide you should ensure that the DM510 installation has been completed as outlined in the Installation Guide. After finishing the commissioning you should then make sure that the dryer operators read the User's Guide, and watch the DM510 Training Videos on YouTube at our DryerMasterMedia channel, or on our website at www.dryermaster.com.

In this guide we will cover:

- a) How to tell the DM510 more about your dryer (holding capacity, throughput etc.),
- b) Calibrating the motor speed control to be able to operate the dryer speed control from the DM510, and
- c) Entering the initial settings for the system.

Do not attempt to use the DM510 to control your dryer before you have completed the commissioning process. The DM510 needs the information you will supply from following this guide in order to provide you with optimal performance.

When you need help there is the Dryer Master Customer Support Centre

One of the unique benefits you receive with the DM510 is access to support from the Dryer Master Support Center where we have experts in the theory (application to drying), installation and operation of the DM510. Personnel are available to answer questions about the material in this guide and other questions you have pertaining to drying.

If you have any questions regarding the installation, commissioning or operation of the DM510 please contact us. You can call the support center toll free from the USA or Canada at 1-888-318-0009, or at 519-725-4700.

A word about passwords

Access to system setup is protected with passwords. The passwords are documented in the appropriate sections of this Guide. In the event someone has blocked out these passwords contact the Dryer Master Support Center to supply you with the system passwords upon request. You may need to specify the system serial number and system location. You can also e-mail info@dryermaster.com with 'DM510 Dryer Master passwords' in the subject line or fax us at 519-885-4300.

Your other Guides

All three of the DM510 guides (Installation, Commissioning and User's) are available for download on the Dryer Master website at www.dryermaster.com/Manuals.htm.

Index

Index..... 3
 Table of figures 4

System Components..... 5

Equipment Schematic 6

System Checkout (General): 7
 Starting-Up the Dryer Master 7
 Before you turn the DM510 on..... 7
 Powering Up the Dryer Master 7
 Set Products 7
 Perform a Printer Test (for systems with a printer) 8
 Setting Alarm Limits 8
 Voltages..... 8

System Checkout (Specific):..... 9
 Checking the Moisture Sensors 9
 Checking Drying Air Temperature Sensor (for systems with temp sensor) 10
 Checking Drying Air Temperature (for systems with signal converter)..... 11
 Checking the Discharge Rate Input & Output signals 12
 Checking the Calibration Button signals 13
 Checking Local Remote Function & Control signals..... 14
 Checking Fan Status signals 15

System Setup & Calibration 16
 Gaining entry to system setup parameters 16

Setup and Calibration - Supervisor Setup 16
 Supervisor Setup, Control Limits:..... 17
 Supervisor Setup, Alarm Actions 18
 Supervisor Setup, Calibration 19
 Supervisor Setup, Deg F deg C conversion 21
 Supervisor Setup, System Shutdown 21

Setup and Calibration - Installer Setup 22
 Discharge Rate setup 23
 Safety Notice: 23
 Calibration of DM510 displayed rate to the dryer’s speed display 23
 Calibration of DM510 rate setpoint – to set rate for the dryer 27
 Moisture Calibration: 31
 Dryer Volumes & Throughput:..... 32
 Dryer Volumes and Throughput – Grain Handler dryers..... 35
 Moisture Sensor Setup: 36
 System Setup:..... 37

Drying Temperature Setup:.....38

Equipment Setup check40

 Setup check list40

Appendix 1: Dryer Volumes and Throughput for Grain Handler dryers.....42

Table of figures

FIGURE 1- APPLICATION SCHEMATIC6

FIGURE 2 - MOISTURE SENSOR CONNECTIONS9

FIGURE 3 - DRYING AIR TEMPERATURE SENSOR CONNECTIONS10

FIGURE 4 - TEMPERATURE SIGNAL CONVERTER WIRING11

FIGURE 5 - DISCHARGE SYSTEM SIGNAL CONNECTIONS AT DRYER MASTER.....12

FIGURE 6 - CALIBRATION BUTTON SIGNAL CONNECTION13

FIGURE 7 - LOCAL REMOTE STATUS AND CONTROL SIGNAL CONNECTION IN THE DRYER MASTER
.....14

FIGURE 8 - FAN STATUS SIGNAL CONNECTIONS IN THE DRYER MASTER15

FIGURE 9 - SETTINGS TYPE MENU16

FIGURE 10 - SETTINGS (SUPERVISOR PASSWORD ENTRY) SCREEN16

FIGURE 11 - SETTINGS (SUPERVISOR SETUP) MENU17

FIGURE 12 - SETTINGS (SUPERVISOR SETUP) CONTROL LIMITS MENU17

FIGURE 13 - SETTINGS (SUPERVISOR SETUP) ALARM ACTIONS MENU18

FIGURE 14 - SETTINGS (SUPERVISOR SETUP) CALIBRATION MENU19

FIGURE 15 - SETTINGS (SUPERVISOR SETUP) TEMPERATURE SCALE MENU.....21

FIGURE 16 - SETTINGS TYPE MENU22

FIGURE 17 - SETUP PASSWORD.....22

FIGURE 18 - INSTALLER SETUP MENU22

FIGURE 19 - DISCHARGE DIAGNOSTICS23

FIGURE 20 - DISCHARGE SETTINGS24

FIGURE 21 – RATE INPUT EXAMPLE CALCULATION 126

FIGURE 22 – RATE INPUT EXAMPLE CALCULATION 2.....26

FIGURE 23 – RATE OUTPUT EXAMPLE CALCULATION 129

FIGURE 24 – RATE OUTPUT EXAMPLE CALCULATION 2.....30

FIGURE 25- SETTINGS (INSTALLER SETUP) MOISTURE CALIBRATION SCREEN31

FIGURE 26 - SETTINGS (INSTALLER SETUP) VOLUMES AND THROUGHPUT SCREEN32

FIGURE 27 - DRYER ZONES33

FIGURE 28 - SETTINGS (INSTALLER SETUP) MOISTURE SENSOR SETUP SCREEN36

FIGURE 29 - SETTINGS (INSTALLER SETUP) SYSTEM SETUP MENU37

FIGURE 30 - SETTINGS (INSTALLER SETUP) TEMPERATURE SCREEN38

System Components

The DM510 system includes the following components:

- DM510 control panel (with remote I/O option)
- Inlet and outlet grain moisture sensors with integral product temperature sensors
- Calibration push button
- Outlet moisture sensor chute with rotary feed (bypass or inline version)
- Drying air temperature sensor or signal converter (to access dryer's temp reading)
- Internet connectivity capability

An optional printer for continuous reporting of dryer operation and results is also available.

DM510 Control Panel:

The DM510 is a computer system complete with user interface keypad and the display screen, I/O system and the capability to provide real time information through an internet connection to an internet capable device. The DM510 Control Panel is typically installed in the control room close to the dryer where it can be readily accessed by the operator. The I/O can be located remotely using a wired connection for short distances or a wireless connection for longer distances (requires optional wireless modems).

Printer (Optional):

The DM510 uses the printer to provide reports such as: Continuous Averages, Hourly Summaries, and Daily Summaries etc. These are tools that can be used to manage the total drying process.

Inlet Moisture and Temperature Sensor:

The inlet moisture and temperature sensor is installed in the flow of the product before it enters the drying zone (hot zone) of the dryer, typically in the garner or holding bin above the hot zone.

Outlet Moisture and Temperature Sensor:

The outlet moisture and temperature sensor is installed where it can receive a representative sample of grain after it exits the cooling zone of the dryer (or the hot zone, if drying all hot).

Calibration Push Button:

The calibration button is installed near the operator sampling point for product exiting the dryer, usually in close proximity to the outlet moisture sensor.

Drying Air Temperature Sensor/Signal Converter:

A temperature sensor is installed in the heating chamber in close proximity to the dryer's existing drying air temperature sensor to monitor the drying air temperature and provide the information to the controller. Some systems will use a temperature signal converter in place of the temperature sensor.

Internet Connectivity Capability:

Connect your DM510 to an internet enabled router or wireless hotspot (via Ethernet cable) and you can access your system remotely via a desktop PC, smartphone or tablet. Simply use your browser to go to my.dryermaster.com and login using the login information that came with your system.

Equipment Schematic

(Standard configuration – See Installation Guide for alternate configurations)

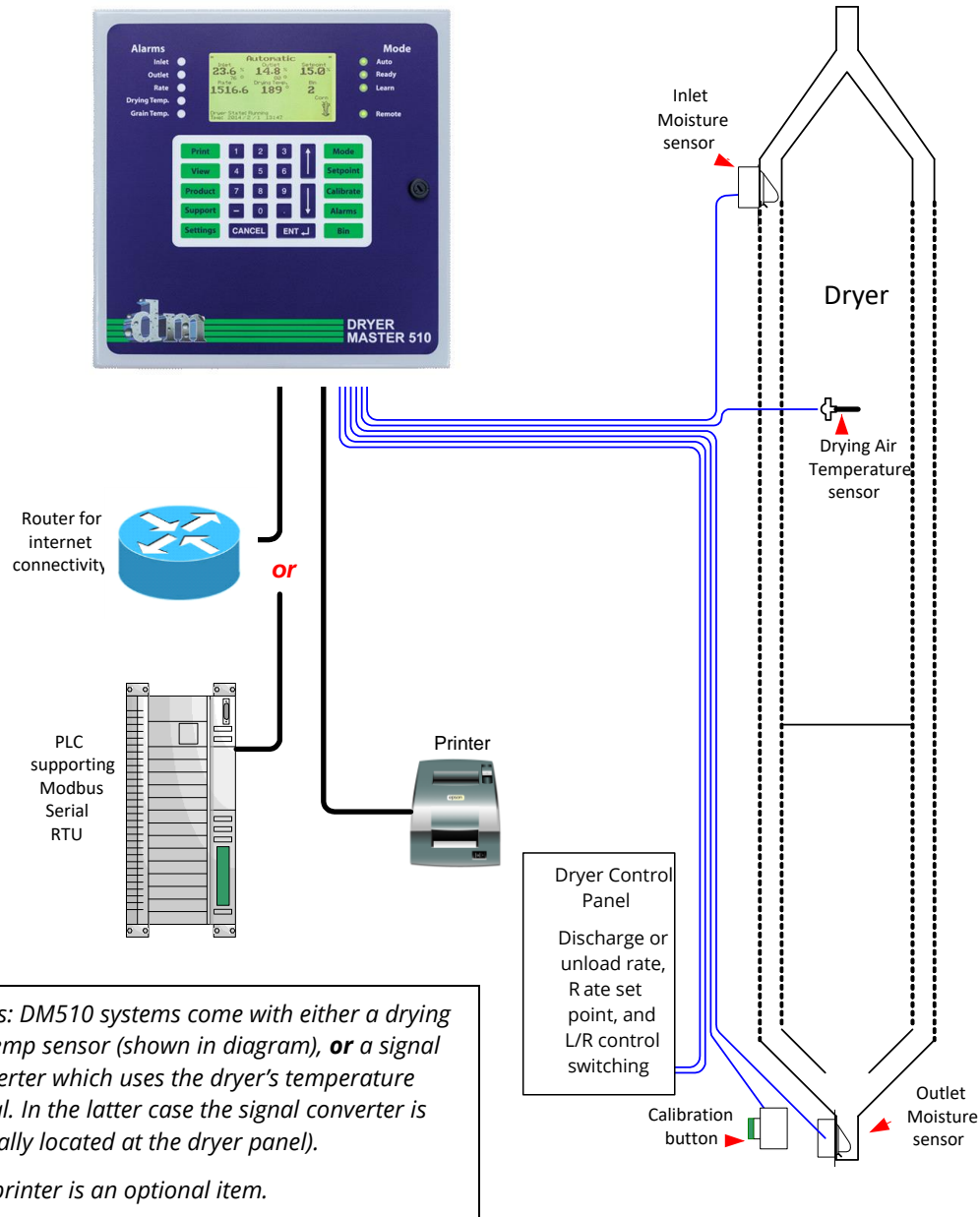

Figure 1- Application Schematic

System Checkout (General):

Before we start configuring the DM510 to your dryer let's begin with a system checkout which will walk you through the wiring and connections at the DM510 side of the installation. This will include checking voltages and testing functions. This section will describe in detail the steps and procedures for completing this task. Should issues arise with wiring at the sensor or dryer please refer to the Installation Manual for more detailed instructions.

Starting-Up the Dryer Master

The "DM510 User's Guide" provides detailed information on the DM510 key pad functionality as well as the information displayed on the LCD screen or via the status lights. We suggest you take a few minutes to review this information before beginning the Commissioning process.

Before you turn the DM510 on

If you have the optional printer, plug the printer into the power outlet and connect the printer cable to the bottom of the DM510. Put the ribbon and paper in the printer if this has not already been done.

Powering Up the Dryer Master

Plug the Dryer Master into the wall outlet or UPS if so equipped. At the bottom of the DM510 panel there is a black switch/fuse. Depress the switch ON, (position 1 is depressed).

When the DM510 is first turned on there will be a blank screen for 20 - 60 seconds. The display will brighten up, and the backlight will illuminate. There may be random characters on the screen. In 10 to 30 seconds, both the alarm and mode lights will flash. The 'Mode' lights will sequence followed by the red alarm lights sequencing. Alarms may sound and the 'Dryer Master' logo will display on the screen. This will be followed by the display of the main operations screen, possibly with an alarm message box. **Press any key to clear the alarm message box and silence the alarm.** Alarms may also occur once the main display is up. Press any key to silence the alarm(s).

The DM510 screen will initially show that you are in 'Local' Mode. This means that the DM510 is not yet controlling anything (control is still at the dryer panel). It is simply monitoring and displaying information.

There may still be alarm lights and possibly mode lights illuminated. This is normal because the DM510 comes with factory settings that may be different than the settings which will be used at your location.

Set Products

The DM510 can be set up to be used for up to 8 different products. For each product that you dry there are certain parameters that you will want to enter separately. These include settings like moisture calibrations and alarm limits. This manual will point out which of the settings are product specific as you go through the commissioning process.

The icon and text at the bottom right corner of your screen tell you what the current product is. To change products, press the 'Product' key and select the desired product and press enter. Refer to the "User's Guide" for detailed instructions on changing products.

Perform a Printer Test (for systems with a printer)

To perform a printer test, press the PRINT button on the keypad and then select (4) Print Test Page. If the page does not print, check that the printer cable is securely connected at both ends and that the printer is on.

Setting Alarm Limits

The DM510 comes with an alarm feature that can help you monitor the drying process. High and low alarm limits can be set for inlet moisture, outlet moisture, drying air temperature, discharge rate and inlet and outlet product temperatures. For each alarm limit there are two stages of alarm. The first stage is a warning alarm and the second stage is a critical alarm. Each stage has an upper and lower limit.

It may be necessary to first set the alarm limits at wide limits during the commissioning process (so they are not always going off) and then reset them during operator training to a state that is compatible with the operation of the dryer. This is best done with the operators during training.

To adjust the Alarm settings, press the "Alarms" button and follow the on-screen instructions or refer to the User's Guide.

Voltages

In the next section you will be asked to check the connections on the DM510. The instructions assume the use of a digital voltmeter. However, it is also possible to check some of the voltages directly from the DM510 panel.

To access the voltage readings, press the **SUPPORT** key and then select **(1) Diagnostics** to get to the first diagnostics screen. Additional diagnostic screens can be accessed by pressing the **down** arrow key.

System Checkout (Specific):

Use this section to check that the installation has been completed correctly and to troubleshoot any components that may not be displaying as they should be.

Checking the Moisture Sensors

Use a Digital Voltmeter set to DC Volts to measure the DC voltage between GND (Black) and the three other wires (Green, Red and White) at the connectors plugged into the isolation card in the DM510 Dryer Master.

The voltages should fall within the ranges shown in Table 1 - Moisture Sensor Voltages. Voltages are measured with respect to 'GND'; both sensors will yield similar results when empty.

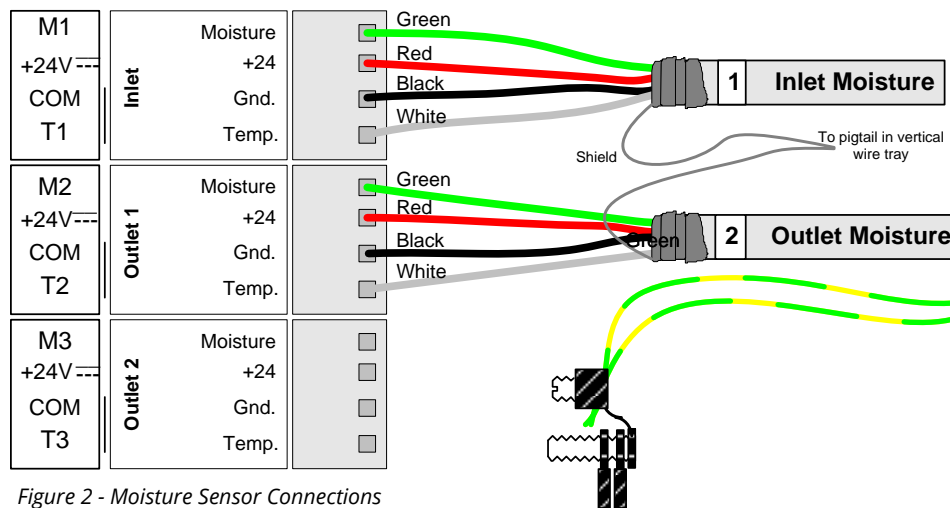

Figure 2 - Moisture Sensor Connections

The moisture sensors' temperature readings are also displayed on the 'Main Operations Screen'

The sensors' moisture voltages are displayed on 'Diagnostics screen 1' as 'Inlet Sensor Signal' and 'Outlet Sensor Signal' (to

access "Diagnostics screen 1" - press "Support" followed by "Diagnostics"). The sensor's temperature voltages are displayed as "Inlet Sensor Temperature" and "Outlet Sensor 1 Temperature". The Outlet 2 readings are only for situations where a system is using 2 outlet sensors.

Wire Colour	Label	Voltage
Green	Moisture	0.5 – 0.9 VDC (empty sensor voltage) - (w.r.t.black wire) 1.0 – 9.0 VDC (with product present) - (w.r.t.black wire)
Red	+24	18 – 30 VDC (w.r.t.black wire)
Black	GND	Common
White	Temp	2.5 – 5 VDC (depending on temperature). To calculate the temperature from this voltage use the following formula: $VDC * 40 - 60 = \text{temperature } ^\circ C$ $VDC * 72 - 76 = \text{temperature } ^\circ F$ Room temperature is approx. 2.93 VDC

Table 1 - Moisture Sensor Voltages

Checking Drying Air Temperature Sensor (for systems with temp sensor)

Use a Digital Voltmeter set to DC Volts to measure the DC voltage between GND (Black) and the two other wires (Red and White) at the connector plugged into the isolation card in the DM510 Dryer Master I/O.

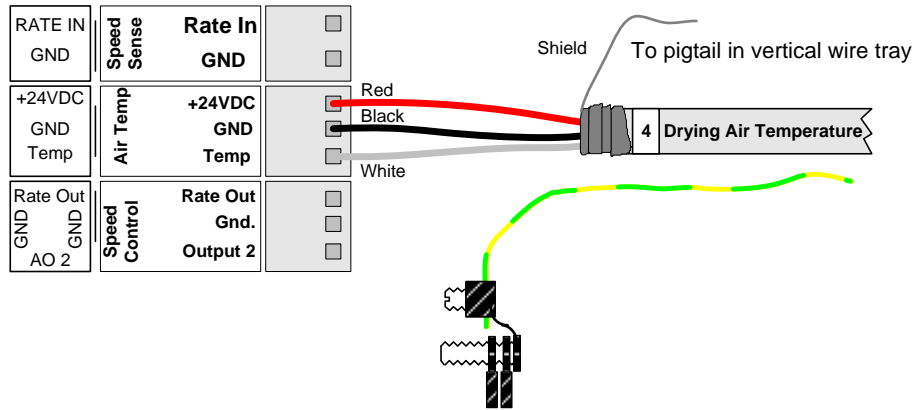

Figure 3 - Drying Air Temperature Sensor Connections

Voltages are measured with respect to 'GND'.

Wire Colour	Label	Voltage
Red	+24	18 – 30 VDC
Black	GND	Common
White	Temp	2.6 – 4 VDC (depending on temperature). To calculate the temperature from this voltage use the following formula: $VDC / 0.01 - 273 = \text{temperature in } ^\circ C$ Convert $^\circ C$ to $^\circ F = ^\circ C * 1.8 + 32 = ^\circ F$

Table 2 - Drying Air Temperature Sensor Voltages

The Temperature signal is displayed on the **'Main Operations Screen'** as well as on the **'Diagnostics screen 1'**.

1. If the displayed temperature is less than $-250^\circ F$ or C , the temperature sensor is not connected or has been damaged.
2. The parameters for the reading can be adjusted under "Drying Temperature Set-up".
 1. Press the "Settings" key, then press "2" for installer setup.
 2. Enter the password "4628", the press "Enter".
 3. Press "7" for Drying Temperature Setup.
 4. Change the "Slope" value (if required) to 0.87391 and press the "Enter" key.
 5. Change the "Offset" value (if required) to -462 and press the "Enter" key.
 6. Press the "Cancel" key several times to return to the main screen.
 7. If necessary, adjust the slope value – each .01 change is approximately $7^\circ F$.
 8. For small adjustments adjust the offset value (1 $^\circ$ less offset is 1 $^\circ$ less temperature).

Checking Drying Air Temperature (for systems with signal converter)

The signal converter should be wired as in Figure 4 - Temperature signal converter wiring . The DM510 drying air temperature should read approximately the same value as on the dryer temperature controller. The converter is programmed for use with a J-type thermocouple. If you are using another type of thermocouple contact the Dryer Master Support Center.

DM 510 Dryer Master to Omega [TXDIN70-24V](#) converter

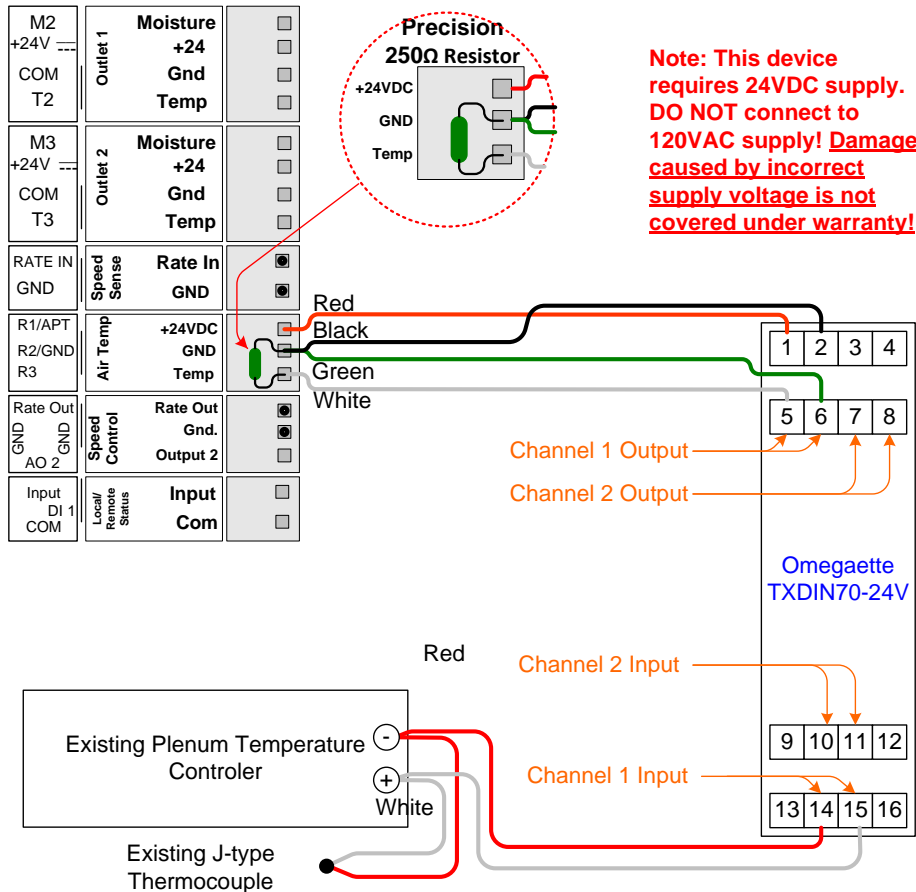

Figure 4 - Temperature signal converter wiring

If the values differ, check the settings on the DM510 as follows:

9. Press the "Settings" key.
10. Press "2" for installer setup.
11. Enter the password "4628".
12. Press "Enter".
13. Press "7" for Drying Temperature setup.
14. With the highlight bar on the slope value change the value (if required) to 0.5 and press the "Enter" key.
15. Use the arrow keys to move the highlight bar to the offset value and change the value (if required) to -112 and press the "Enter" key.
16. Press the "Cancel" key several times to return to the main screen.

Checking the Discharge Rate Input & Output signals

With the dryer’s discharge system running. Use a Digital Voltmeter set to DC Volts to measure the DC voltage between GND (White) and Rate In (Green) as well as Rate Out (Red) and GND (Black) at the connectors plugged into the isolation card in the DM510 Dryer Master.

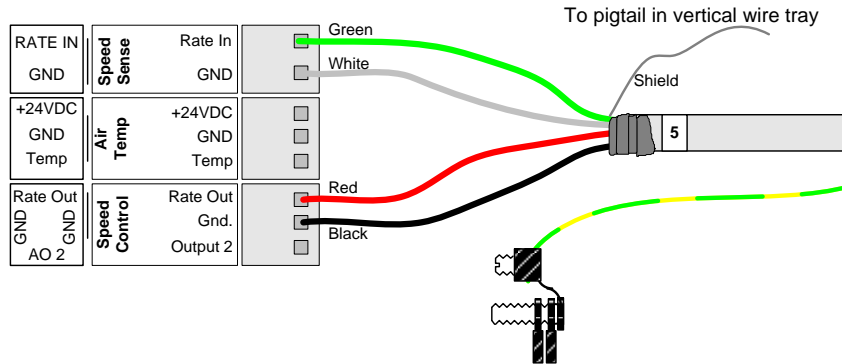

Figure 5 - Discharge System Signal Connections at Dryer Master

Voltages are measured with respect to ‘GND’.

Wire Colour	Label	Voltage
Red	Rate Out	0 -10 VDC (Depending on Discharge Speed)
Black	GND	Common
White	GND	Common
Green	Rate In	0 -10 VDC (depending on Discharge Speed)

Table 3 - Discharge System Signal Voltages

These tests are performed with the DM510 in ‘Local’ mode. In ‘Local’ mode the DM510 sets the ‘Rate Out’ signal proportionately to the ‘Rate In’ signal. The default setup is such that 100% rate approximately equals 10 volts. The ‘Rate Out’ signal is governed by the high and low control limits and may not be able to reach 0VDC or 10VDC. Refer to Figure 12 - Settings (Supervisor Setup) Control Limits menu for setting the control limits.

1. If there is no **‘Rate In’** signal, the dryer is not running or there is an issue with the wiring.
2. There is a Rate indication on the DM510 ‘Main Operations screen’. The Rate changes as the dryer panel speed potentiometer is adjusted, but the speed displayed on the DM510 ‘Main operations screen’ is not the same as indicated by the dryers speed display. A calibration of the rate signal is required at the DM510 to correct this discrepancy. This will be covered in detail later in this guide.

Checking the Calibration Button signals

Press the Calibration button and hold for a few seconds to start the lamp flashing. The flashing lamp followed by a solid light 30 seconds later indicates the button and lamp are wired correctly. If this is not the case use a Digital Voltmeter, set to DC Volts to measure the DC voltages as described in Table 4 - Calibration Button Signal Voltages' and correct the wiring accordingly. The light goes out in a few seconds if the sensor is empty.

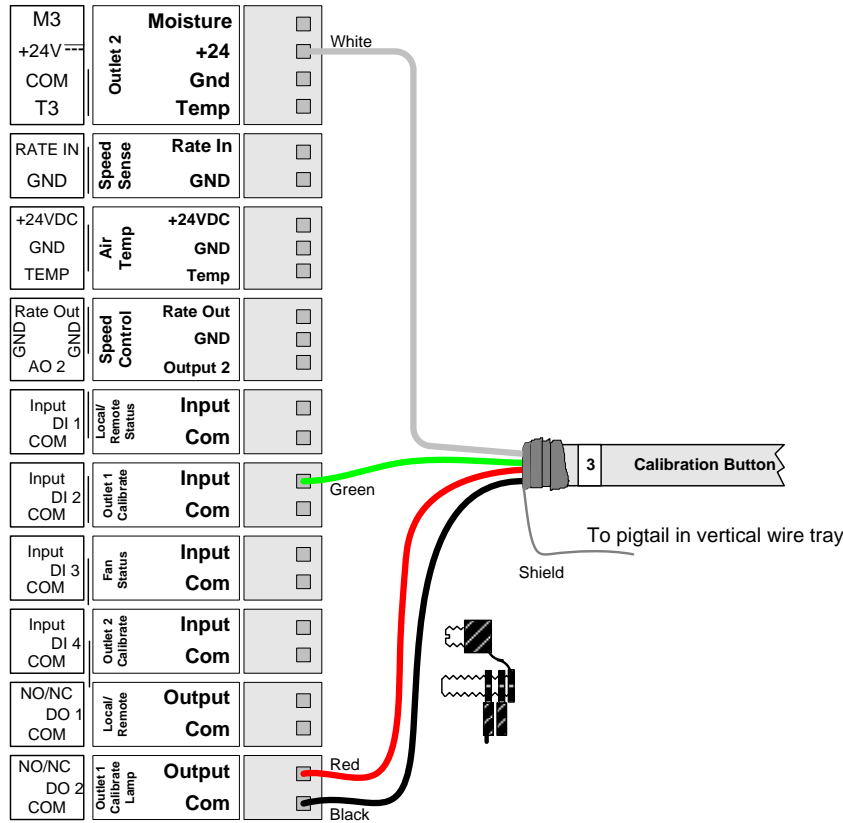

Figure 6 - Calibration Button Signal Connection

Voltages are measured with respect to 'GND'.

Wire Colour	Label	Voltage
White	+24VDC	+ 20 to 28 VDC to the button switch N.O terminal
Green	DI 2 (Input)	From button switch COM terminal (+20 to 28 VDC while button pressed)
Red	DO2 NC/NO (Output)	+ 20 to 28 VDC when lamp is illuminated. Lamp is illuminated anytime an outlet calibration is in progress.
Black	DO2 COM (Com)	Note: DO2 COM terminal is internally connected to 'GND'

Table 4 - Calibration Button Signal Voltages

Checking Local Remote Function & Control signals

Local/Remote switching is an integral part of the DM510 Dryer Master controlling the discharge of the dryer. In 'Local' mode the DM510 serves to monitor the operation and provides information for the operator to control the Dryer. In 'Manual' and 'Automatic' modes the rate is set from the DM510 panel. The figures below show the required wiring. The operation will be tested as part of the rate output calibration in the section **Calibration of DM510 rate setpoint - to set rate for the dryer.**

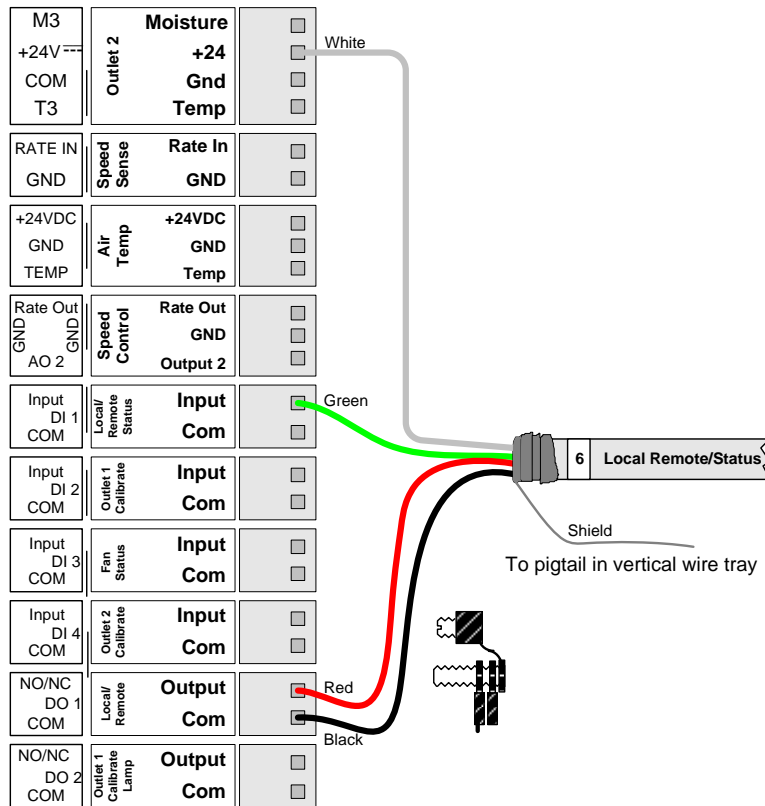

Figure 7 - Local Remote status and control signal connection in the Dryer Master

Voltages are measured with respect to 'GND'.

Wire Colour	Label	Voltage
White	+24VDC	18 – 30 VDC to the Local/Remote Relay N.O terminal
Green	DI 1 (Input)	From the Local/Remote Relay COM terminal (18 – 30 VDC while Relay is energized)
Red	DO1 NC/NO (Output)	18 – 30 VDC when the Local/Remote Relay is Energized. Anytime the 'Remote' light is illuminated.
Black	DO1 COM (Com)	Note: DO1 COM terminal is internally connected to 'GND'

Table 5 - Local Remote status and control signal voltages

Checking Fan Status signals

The Fan Status signal provides the DM510 Dryer Master a direct indication of the dryer’s state of operation. In systems where this signal is not available the Dryer temperatures falling below the ‘OFF’ temperature parameter setting and the rate falling below the ‘OFF’ rate parameter setting indicate to the DM510 that the dryer has been shut down.

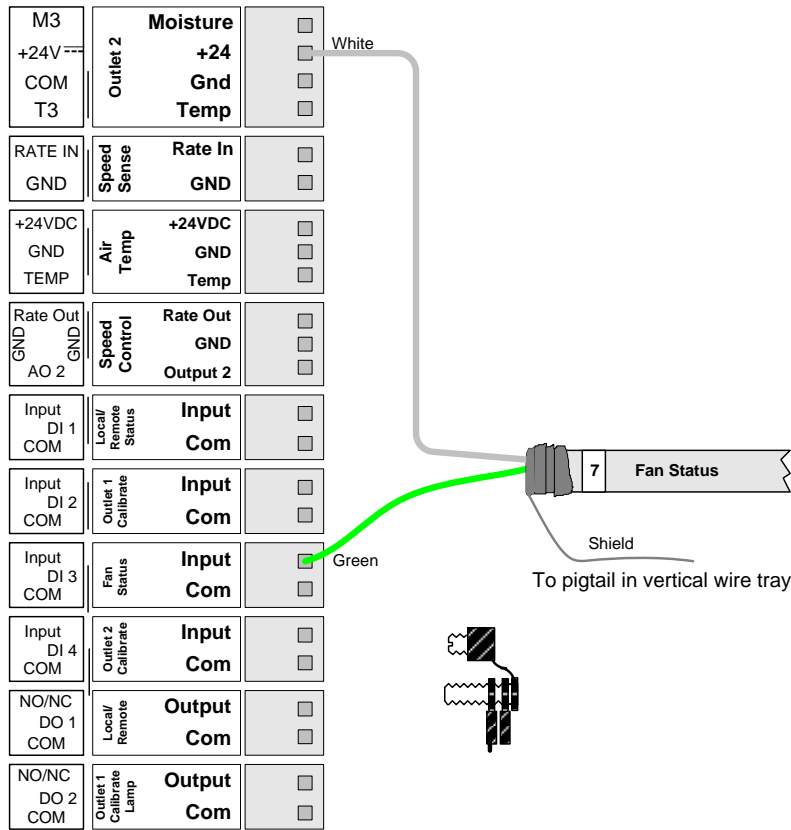

Figure 8 - Fan Status signal connections in the Dryer Master

Voltages are measured with respect to ‘GND’.

Wire Colour	Label	Voltage
White	+24VDC	18 – 30 VDC to the Local/Remote Relay N.O terminal
Green	DI 3 (Input)	From the Local/Remote Relay COM terminal (18 – 30 VDC while Relay is energized)

Table 6- Fan status signal voltages

The signal checkout at the DM510 Dryer Master is now complete. The next stage will involve calibrating the system by setting system parameters.

System Setup & Calibration

System setup and calibration involves setting a number of parameters to tune the DM510 Dryer Master to the dryer. This section will describe in detail the steps and procedures for completing this task. There will be checks to verify the steps have been performed correctly. The system setup can be performed completely from the Dryer Master DM510 keypad and console. A calculator is required.

Gaining entry to system setup parameters

Access to the **Supervisor** setup menus and screen as well as the **Installer** setup menus and screens are protected by numeric passwords. This is to prevent the casual user or just anyone from inadvertently adjusting the systems setup values. There are different passwords for the supervisor setup and the installer setup. These passwords are hard coded and therefore not changeable by the user.

Setup and Calibration - Supervisor Setup

Under Supervisor setup you will enter values for some of the basic control parameters.

- Press the 'Settings' key to display the 'Settings Type' menu.
- Press the '**1**' key to select "Supervisor Setup".
Or
- Press the '**arrow**' keys to highlight the selection followed by the '**Enter**' key
- Press '**Cancel**' to return to the '**Main Operations Screen**'.

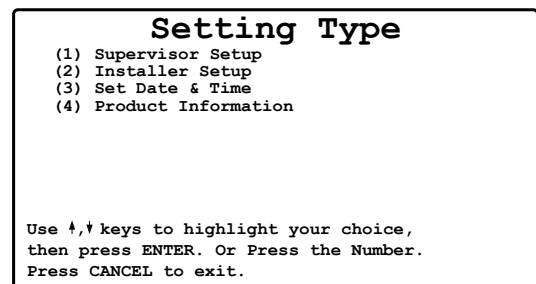

Figure 9 - Settings Type Menu

- Type the '**password**' followed by the '**Enter**' key to gain access. (Password = 123)
- Press '**Cancel**' to return to the '**Main Operations Screen**'.

Supervisor Password = "**123**"



Figure 10 - Settings (Supervisor Password entry) screen

Supervisor Setup

- Press the **'number'** key to select the item.
Or
- Press the **'arrow'** keys to highlight the selection followed by the **'Enter'** key
- Press **'Cancel'** to return to the **'Main Operations Screen'**

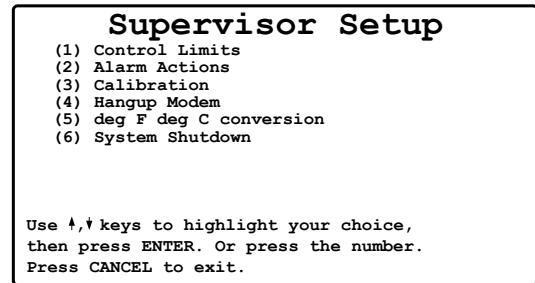

Figure 11 - Settings (Supervisor Setup) menu

Supervisor Setup, Control Limits:

- Press the **'arrow'** keys to highlight the selection. Type in the **'value'** followed by the **'Enter'** key. (See chart below for guidelines on values to use. You should set these up separately for each different product that you dry)
- Press **'Cancel'** to return to the **'Previous Menu'**.

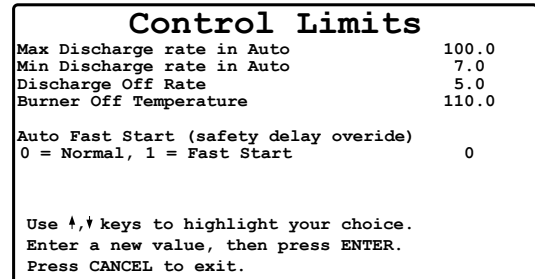

Figure 12 - Settings (Supervisor Setup) Control Limits menu

Max Discharge rate in Auto	This is the maximum discharge or unload rate that can be set by the DM510 Dryer Master. Set this value to a reasonable maximum that will not compromise safe dryer operation. Setting this value ensures the conveying system is able to manage the volume of product.
Min Discharge rate in Auto	This is the minimum discharge or unload rate that can be set by the DM510 Dryer Master. Set this value to a reasonable minimum that will not compromise safe dryer operation.
Discharge Off Rate	The DM510 Dryer Master uses this value along with drying temperature to determine the dryer state. Set this value to slightly less than the 'Minimum Discharge rate in Auto'. Automatic control will be severely compromised if this value is set so that the DM510 does not obtain an OFF indication. Do not set = 0.
Burner Off Temperature	The DM510 Dryer Master uses this value along with discharge or unload rate to determine the dryer state. Set this to a value greater than the maximum expected ambient temperature but less than the minimum drying temperature. Automatic control will be severely compromised if this value is set so that the DM510 does not obtain an OFF indication. Typically set about 30 degrees F below your drying temperature.
Auto Fast Start	In normal operation the DM510 Dryer Master determines when it is ready for Automatic operation. This process can take from a few minutes to a dryer load or more. The Auto Fast Start feature bypasses the DM510 feature that determines stable operation. With Auto fast start the DM510 Dryer Master can be placed into Automatic before the 'Ready light' is illuminated. A warning message with instructions will be displayed when selecting Automatic before the 'Ready light' is illuminated. Standard setup is 0 = Normal

Supervisor Setup, Alarm Actions

- Press the **'arrow'** keys to highlight the selection. Type in the **'value'** followed by the **'Enter'** key
Or
- Press the **'Enter'** key to toggle the states.
- Press **'Cancel'** to return to the **'Previous Menu'**.

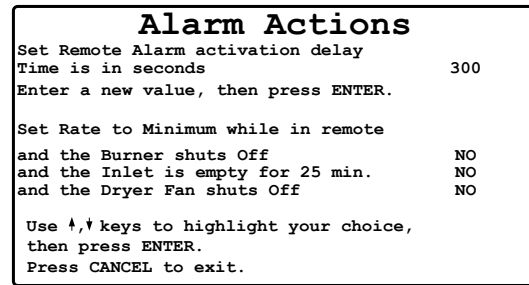





Figure 13 - Settings (Supervisor Setup) Alarm Actions menu

Remote Alarm Activation Delay	<p>The DM510 Dryer Master provides a contact for an external remote alarm. The delay provides the user with time to cancel the system alarm before the remote alarm is activated.</p> <p>The time is set in seconds.</p>
Set Rate to minimum when the burner shuts OFF.	<p>Note:</p> <p><i>This feature, when enabled, ('YES' displayed and the 'Remote light' illuminated) will reduce the dryer discharge rate to the minimum value previously entered in the 'Control Limits' menu 'Min Discharge rate in Auto' value. The Burner OFF trigger is either the 'Burner Off Temperature' value or a wired connection.</i></p> 
Set Rate to minimum when the inlet has been empty for 25 minutes.	<p>Note:</p> <p><i>This feature, when enabled, ('YES' displayed and the 'Remote light' illuminated) will reduce the dryer discharge rate to the minimum value previously entered in the 'Control Limits' menu 'Min Discharge rate in Auto'.</i></p> 
Set Rate to minimum when the Dryer Fan shuts OFF.	<p>Note:</p> <p><i>This feature, when enabled, ('YES' displayed and the 'Remote light' illuminated) will reduce the dryer discharge rate to the minimum value previously entered in the 'Control Limits' menu 'Min Discharge rate in Auto'.</i></p> <p><i>This feature only functions if the Dryer Fan run signal is wired to the DM510 Dryer Master. The DM510 will not properly control the discharge if enabled without the Dryer Fan signal.</i></p> 

Note:

The Alarm Actions are CRITICAL for proper system operation. Review and adjust as required. The Dryer Master is not a substitute for improperly functioning Dryer safety equipment. If in doubt do not enable these items.

Supervisor Setup, Calibration

- Press the **'arrow'** keys to highlight the selection. Type in the **'value'** followed by the **'Enter'** key
- Press **'Cancel'** to return to the **'Previous Menu'**

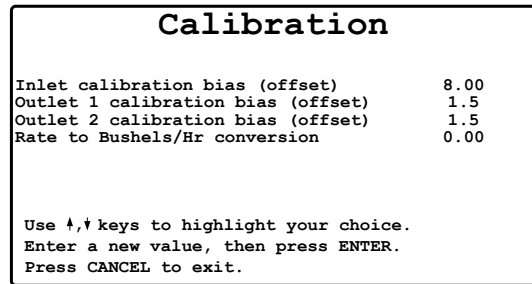

Figure 14 - Settings (Supervisor Setup) Calibration menu

Note:

Adjusting the calibration values impacts the displayed moisture readings. A change in the moisture readings will have an impact on control. It is best to return the DM510 to manual control before making adjustments to the sensor calibrations.

<p>Inlet calibration bias (offset)</p>	<p>The displayed value is a bias or offset applied to the combined temperature and dielectric signals returned from the DM510 moisture sensor. Adjusting this value has a direct impact on the displayed moisture value on the 'Main Operations Screen.' The DM510 calibration procedure also has an impact on this and other values when calibrations are performed.</p>				
<p>Outlet 1 calibration bias (offset)</p>	<p>Before adjusting this value cancel any calibration in progress and note the displayed bias value.</p>				
<p>Outlet 2 calibration bias (offset) - only in cases with 2 outlet sensors</p>	<p>Example of Inlet calibration adjustment:</p> <table style="margin-left: 40px;"> <tr> <td>DM510 Inlet reading</td> <td>= 26.5%</td> </tr> <tr> <td>Manual test</td> <td>= 21%</td> </tr> </table> <p>The DM510 needs to read 5.5 lower.</p> <p style="text-align: center;">26.5 - 21 = 5.5</p> <p>Reduce the 'Inlet calibration bias (offset)' value by 5.5</p> <p style="text-align: center;">8 - 5.5 = 3.5</p> <p>Outlet adjustments are made similarly. To increase the displayed moisture reading the displayed bias value needs to be increased by the required amount. To decrease the displayed moisture reading the displayed bias needs to be decreased by the required amount. It should be noted the bias value can be a negative number.</p>	DM510 Inlet reading	= 26.5%	Manual test	= 21%
DM510 Inlet reading	= 26.5%				
Manual test	= 21%				

Rate to Bushels/Hr Conversion

This is the conversion of the discharge or unload rate to bushels per hour. It is used to calculate the production numbers for Summary Reports.

To calculate this value requires 3 items.

- 1) Product volume = bushels
- 2) Time = minutes
- 3) Discharge rate = DM510 rate

For example;

If the dryer discharges **4500** Bushels in **1 hr 37minutes** at a discharge rate of **80%** then the conversion factor is **34.7925**.

- 1) **1 hr 37 minutes = 60 + 37 = 97** minutes
- 2) Bushels per minute = **4500 / 97 = 46.39**
- 3) Bushels per hour = **46.39 * 60 = 2783.4**
- 4) Bushels / hour conversion = **2783.4 / 80 = 34.7925**

The value to be entered as the '**Rate to Bushels/Hr Conversion**' factor is **34.7925**.

The Accuracy of the value depends on the accuracy of the measurements. This is in the 'Approximate Production' output in the printed 'Bin Summary' and the 'Daily Summary'

Note: If the discharge rate is displayed in bushels per hour then the conversion factor is 1.0.

Note: The conversion factor is linear and proportional to the reported production volumes. Therefore, if the reported production volume is in error adjust the conversion factor by the same percent. So for example if the reported production volume is 10% too high then lower the conversion factor by 10%.

Hang up Modem

This feature is no longer available.

Supervisor Setup, Deg F deg C conversion

The **'Deg F deg C conversion'** menu permits changing the temperature scale between Fahrenheit and Celsius

- Press the **'number'** key to select the item.
Or
- Press the **'arrow'** keys to highlight the selection followed by the **'Enter'** key
- Press **'Cancel'** to return to the **'Previous Menu'**

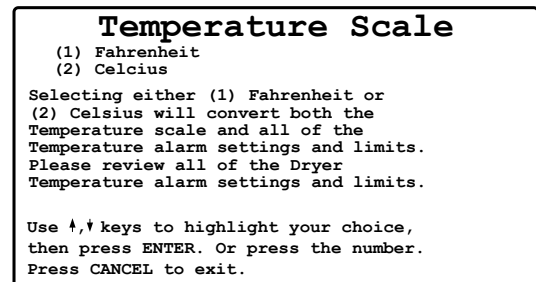

Figure 15 - Settings (Supervisor Setup) Temperature Scale menu

Note:

Changing from Fahrenheit to Celsius or vice versa will also convert all the temperature alarm settings and temperature limits to factory default values. It will be necessary to review and adjust temperature alarm settings and temperature limits after a conversion has been made.

Supervisor Setup, System Shutdown

System shutdown is a controlled shutdown of all the system software much like the shutdown of a PC. The system will display the Dryer Master Logo and exit all software. It is safe to turn OFF the power once the Dryer Master Logo is displayed.

To restart the system, wait 5 seconds, then turn the system ON.

Setup and Calibration - Installer Setup

The settings in this section are typically not adjusted once you start drying, unless you make changes to your dryer or discharge system. In this section you will tell the DM510 more about your dryer and you will calibrate the discharge rate settings so that the DM510 and the dryer are reading the same values. If you need some help at this point in the commissioning process please contact the Dryer Master Support Center.

Press the **'Settings'** key to display the **'Settings Type'** menu.

- Press the **'2'** key to select the item.
Or
- Press the **'arrow'** keys to highlight the selection followed by the **'Enter'** key
- Press **'Cancel'** to return to the **'Main Operations Screen'**.

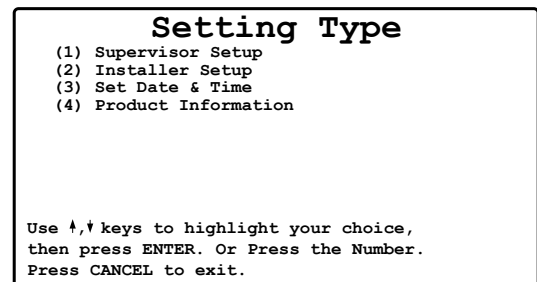

Figure 16 - Settings Type menu

- Type the **'password'** followed by the **'Enter'** key to gain access. (Password = 4628)
- Press **'Cancel'** to return to the **'Main Operations Screen'**.

Installer Password = "4628"



Figure 17 - Setup Password

- Press the **'number'** key to select the item.
Or
- Press the **'arrow'** keys to highlight the selection followed by the **'Enter'** key
- Press **'Cancel'** to return to the **'Main Operations Screen'**

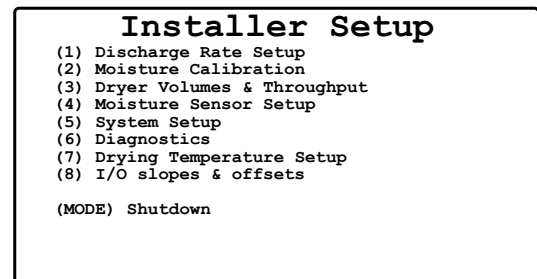

Figure 18 - Installer Setup menu

Discharge Rate setup

Discharge Rate setup involves calibrating the DM510 displayed rate to the dryer's unload rate display and calibrating the DM510 control output to run the dryer at the requested rate. Dryers with no discharge or unload rate display will be calibrated for 0 to 100% to coincide with 0 to 100% speed of the dryers unload system.

Steps to calibrating and setting up the discharge system:

1. Calibration of DM510 displayed rate to the dryer's speed display (DM510 in LOCAL mode)
2. Calibration of DM510 rate setpoint (DM510 in MANUAL mode)
3. Turning speed setpoint 'PID Control Loop' 'ON'

Safety Notice:

It is best to perform the discharge calibration with the dryer empty and only the unload system running.

If you must perform the discharge calibration while actually drying grain you must use extreme caution. It is possible for the unload to stop completely. Under this condition dryer safety circuits may shut the dryer down. Extended dryer operation with the unload stopped may cause a fire resulting in personal injury or death.

It is also possible for the unload to go to maximum speed resulting in plugging of the dry conveying system and/or equipment damage.

Follow the instructions in this guide carefully and/or call the Dryer Master Support Center for assistance.

Calibration of DM510 displayed rate to the dryer's speed display

The objective of this step is to have the **Rate Input** value on the Discharge Diagnostics screen read the same as the **rate displayed to the operator from the dryer control panel**. This is done by adjusting the **Rate Input Slope** and **Rate Input Offset** on the Discharge Settings screen. It is preferable that this step be completed when you are not drying, as it will be necessary to run the dryer discharge at various speeds.

- Select 'Discharge Rate Setup' to display the 'Discharge Diagnostics' screen.
- The L/R Status should read LOCAL
- To move to the '**Discharge Settings**' screen press '**Settings**'

Discharge Diagnostics		
Rate Input Slope		0.09766
Rate Input Offset		0.0
Rate Output Slope		10.000
Rate Output Offset		0.000
PID Control Loop		OFF
L/R Status		Local
Rate Input	Rate SP	Rate Output
55.3	55.0	54.7
Press SETTINGS for rate setup.		
Press CANCEL to exit.		

Figure 19 - Discharge Diagnostics

The values **'Rate Input'**, **'Rate SP'**, **'Rate Output'** are the current values within the system. The **Rate Input** is the same as the value displayed on the **'Main Operations Screen'**.

All values can be changed and set by pressing **'Settings'** to display the **'Discharge Settings'** screen.

- Press the **'arrow'** keys to highlight the selection. For the value location type a new **'value'** followed by the **'Enter'** key. For the **'text'** location press the **'Enter'** key to toggle the state.
- Press **'Cancel'** to return to the **'Discharge Diagnostics'** screen

Discharge Settings	
Rate Input Slope	0.09766
Rate Input Offset	0.0
Rate Output Slope	5.000
Rate Output Offset	0.000
Rate Input Filter	0.50
Max Auto Discharge	100.0
Min Auto Discharge	7.0
Manual Discharge SP	50.0
PID Gain (Kp)	0.10
PID Control Loop	OFF
L/R Status	Local

Figure 20 - Discharge Settings

Rate Input Slope:	The conversion of rate input voltage to displayed value.
Rate Input Offset:	The offset or bias of the rate input voltage to displayed value.
Rate Output Slope:	The conversion of displayed value to a rate output voltage.
Rate Output Offset:	The offset or bias of the displayed value to a rate output voltage.
Rate Input Filter:	Filter value for the displayed rate. 0.0 no filter, 0.99 maximum filter
Max Auto Discharge:	The maximum permitted discharge rate setpoint from the supervisor 'Control Limits' screen.
Min Auto Discharge	The minimum permitted discharge rate setpoint from the supervisor 'Control Limits' screen.
Manual Discharge SP:	Manual rate setpoint
PID Gain (Kp):	Speed setpoint error recovery gain. With an error in the displayed rate to output signal, this value sets the speed of the recovery. Value should not be changed.
PID Control Loop:	<p>OFF, ON Loop MUST be turned off for calibration.</p> <p>This item in conjunction with the 'PID Gain (Kp)' value permits the DM510 system to recover from small calibration errors or drift in the dryer's discharge systems speed control. It is recommended that this be turned on for systems with DC motor speed controls as these are not as capable as Variable Frequency drives of locking in a speed.</p>
L/R Status:	Switches between Local (running from the Dryer panel) to Remote (DM510 setting the speed). Permits switching back and forth for setup purposes without returning to the 'Main Operations Screen'

Calculating Rate Input values:

Rate Input Slope: The conversion of rate input voltage to displayed value.

Rate Input Offset: The offset or bias of the rate input voltage to displayed value.

Suggested procedure for calibration:

1. Set the initial **Rate Input Slope** according to the chart below
2. Set the dryer rate to about 75% of the maximum safe speed
3. Adjust the slope to correct the error. Determine the new slope using the method shown in "Rate Input Example Calculation 1" below
4. Set the dryer rate to about 25% of maximum safe speed
5. Adjust the **Rate Input Offset** to correct the reading. Note that the **Rate Input Offset** is directly proportional to the displayed rate. Changing the offset by 10 will change the displayed rate by 10.
6. Repeat steps 2 through 5 several times until no correction is required at either speed.

Suggested Initial Rate In Slope setting to begin calibration: (voltage refers to maximum output of the unload drive)

Maximum Unload Speed	5V	10V
10	.02	.01
100	0.2	0.1
1000	2.0	1.0
5000	10.0	5.0
10000	20.0	10.0

Table 7 - Suggested initial Rate In Slope Settings

Rate Input Example calculation 1:

Input channel specification:

The rate input voltage range is 0 to 10 VDC.

The channel resolution is 10 bits. This equates to 10 volts being divided into 1023 steps.

Most times the input relationship is linear. This means the offset remains at 0.	To calculate the new slope: a) Example values: Actual rate of discharge system 50 DM510 displayed Rate (Rate Input) 80 Rate Input Slope 0.09766
--	---

	<p>b) Actual rate / DM510 displayed rate * 'Rate Input Slope' = new 'Rate Input Slope'.</p> <p>c) Therefore: $50 / 80 * 0.09766 = 0.0610375$</p> <p>The 'Rate Input Slope' would change from 0.09766 to 0.0610375</p>
--	---

Figure 21 – Rate Input Example calculation 1

Rate Input Example calculation 2:

Input channel specification:

The rate input voltage range is 0 to 10 VDC. Converting 4 –20 mA to voltage requires a 250ohm precision resistor for conversion to 1-5 VDC or a 500 ohm precision resistor for conversion to 2 –10 VDC. If 1 – 5 VDC is used see the Installation manual for setting the input range jumper on the I/O board.

The channel resolution is 10 bits. This equates to 10 volts being divided into 1024 steps.

<p>This situation is for systems where the DM510 displayed value is not a linear relationship or the speed control outputs a rate signal when at 0. Common in systems with either, 1 –5 VDC or 4 – 20 mA rate output signals. In these situations both the 'Rate Input Slope' and the 'Rate Input Offset' requires adjustment.</p>	<p>To calculate the new slope:</p> <p>a) To calculate the range for 2 to 10 VDC to display 0 – 100% Resolution is 1024 bits / 10 volts = 102.4 bits per volt. Therefore: 2 volts = 102.4 * 2 = 204.8 = RawA 10 volts = 102.4 * 10 = 1024 = RawB</p> <p>0% = DisplayA 100% = DisplayB</p> <p>b) To calculate the Rate Input Slope: $(DisplayB - DisplayA) / (RawB - RawA)$</p> <p>c) To calculate the Rate Input Offset: $(DisplayA - RawA) * Rate Input Slope$</p> <p>d) Therefore: $(100 - 0) / (1024 - 204.8) = 0.1220703$ = new 'Rate Input Slope' $(0 - 204.8) * 0.1220703 = -25$ = new 'Rate Input Offset'</p>
--	--

Figure 22 – Rate Input Example calculation 2

The system should be checked at one or two different rate settings on the dryer motor speed control to ensure that the **Rate Input** reading displayed on the DM510 is very close to the motor speed control setting. You may need to make some additional adjustments to the **Rate input slope** and **Rate input offset** settings to do this.

Calibration of DM510 rate setpoint – to set rate for the dryer

If you have problems with this step please contact the Dryer Master Support Center for assistance.

The objective of this step is to have the **Rate SP** value on the Discharge Diagnostics screen read the same as the **Rate Input** value at different typical rate setpoints, while in Remote mode. This is to ensure that the dryer discharge will run at the speed requested by the DM510. This part of the calibration is done by adjusting the **Rate Output Slope** and **Rate Output Offset** on the Discharge Settings screen, and should only be done AFTER the Rate Input has been calibrated (see previous section).

As part of the rate calibration process, you will need to select MANUAL mode for the first time. In MANUAL mode the DM510 sends a rate signal to the dryer motor speed control. The DM510 has initial values for the calibration but because motor speed controls differ it is likely that these settings will need some adjustment, and in some cases major adjustment to complete the calibration.

Again, it is preferable that this step be completed when you are not drying, as it will be necessary to run the dryer discharge at various speeds.

Calculating Rate Output values:

Rate Output Slope: The conversion of displayed value to a rate output voltage.

Rate Output Offset: The offset or bias of the displayed value to a rate output voltage.

Suggested procedure for calibration – Part 1:

1. Make sure that the **Rate In** has been calibrated before continuing.
2. Go to the Supervisor Setup, Control Limits and set the minimum and maximum speeds wide enough apart to allow the speed to be adjusted (SETTINGS Key, then 1-Supervisor setup, then "123" (password), then 1-Control limits). Cancel to return to Main Screen.
3. Go to the Alarm Limits (ALARMS key, then Set Alarm Limits) and set the Rate alarms out of range to prevent nuisance alarms during the calibration procedure.
4. At the "Dryer Diagnostics" screen press the SETTINGS key to get to the "Discharge Settings" screen. There are suggested initial **Rate Output Slope** values in Table 8 - Suggested initial Rate Output Slope settings below
5. The **Manual Discharge SP** value will show the current rate in LOCAL mode as set at the dryer motor speed control.
6. Scroll down to the **L/R Select** line using the arrow keys. Local is control from the dryer and Remote is control from the DM510.
7. With the cursor on Local, press **Enter** and then **Cancel** to return to Discharge Diagnostics.
8. The green Remote light (to the right on the LCD screen) should illuminate and the **Rate SP** value on the Discharge Diagnostics Screen will start to change.

*Note: If the new **Rate SP** value is outside of the operating range of the dryer discharge system return the mode to Local immediately by pressing SETTINGS and then changing the L/R Select entry back to Local by pressing **Enter** and then **Cancel**.*

Troubleshooting:

1. If the **'Remote'** light does not illuminate when selecting **'Remote'** and requesting a speed the safety run timer in the DM510 may have expired. To reset this timer, restart the DM510. This Safety Run timer takes 25 minutes to expire and is usually the result of running the system in **'Manual'** mode without a displayed Rate or Inlet and Outlet moistures.
2. If changing the rate in **'Manual'** mode results in no speed change and the **'Remote'** light is illuminated and the DM510 has not taken control, there is likely a problem with the wiring to the local/remote control relay in the dryer panel, or to the MSCI board if a DC drive is used.
3. If changing to **'Remote'** results in the rate going to '0' and the voltage tests described in section "Checking the Discharge Rate Input and Output Signals" are correct, there might be an issue with the wiring to the speed control, or the setup of the speed control itself. In dryers with older DC motor drives, the installation of the Dryer Moisture Systems Inc. supplied Motor Speed control interface might be at fault. Refer to the installation manual for installation information to correct this condition.
4. If changing to **'Remote'** results in a speed either higher or lower than the requested speed and the speed changes when asking for different speeds then the system requires calibration to either the rate input or the rate output signal.

Suggested procedure for calibration - Part 2:

1. With the DM in **"Remote"** mode, select a speed that is about 50% of the maximum safe speed (on the Discharge Settings screen change the **Manual Discharge SP** value), and watch closely the response of the dryer. If the speed exceeds safe limits immediately place the system back into **Local Mode** and select an appropriate value for the **Rate Output Slope**.
2. Change the rate setpoint from 50% to 75% of the safe maximum speed, or if necessary a value less than 75% to prevent the system from unloading too fast.
3. Adjust the **Rate Output Slope** to correct the error.
4. Change the rate setpoint to 25% of the maximum safe speed.
5. Adjust the **Rate Output Offset** to correct the error. Note the **Rate Output Offset** is NOT in rate units. A change in offset of 102 will change the output voltage by about 1V. So, for example if the maximum unload speed is 5000 and the error is 50 then:

$$5000\text{bu/hr} / 10\text{V} = 500 \text{ bu/hr} / 1 \text{ volt}$$

Therefore to correct a 50 error we need to change the output by 0.1V

So we get 102 steps per 1 volt is 10.2 steps per 0.1V

So the offset entry would be 10.2
6. Repeat steps 2 through 5 until no correction is required at either speed.
7. If the maximum unload speed is 1000 or less turn the **PID Control Loop** to **ON**. If the maximum unload speed is greater than 1000 turning the PID Control Loop on may result in discharge rate "hunting". If this occurs simply turn off the PID Control Loop
8. Return your Control Limits and Alarm Limits (that were widened above to allow for calibration) back to their previous settings.

Suggested Initial Rate Output Slope setting to begin calibration: (voltage refers to maximum input to the unload drive)

Maximum Unload Speed	5V	10V
10	50	100
100	5	10.0
1000	0.5	1.0
5000	0.1	0.2
10000	0.05	0.1

Table 8 - Suggested initial Rate Output Slope settings

Rate Output Example calculation 1:

Output channel specification:

The rate output voltage range is 0 to 10 VDC.

The channel resolution is 10 bits. This equates to 10 volts being divided into 1024 steps.

<p>Most times the output relationship is linear. This means the offset remains at 0.</p>	<p>To calculate the new slope:</p> <ul style="list-style-type: none"> • Example values: <table style="margin-left: 20px;"> <tr> <td>Rate SP value</td> <td style="text-align: right;">50</td> </tr> <tr> <td>DM510 displayed Rate (Rate Input)</td> <td style="text-align: right;">80</td> </tr> <tr> <td>Rate Output Slope</td> <td style="text-align: right;">10.23</td> </tr> </table> • Rate SP / DM510 displayed rate * 'Rate Output' = new 'Rate output Slope'. • Therefore: $50 / 80 * 10.23 = 6.39375$ <p>The 'Rate Output Slope' would change from 10.23 to 6.39375</p>	Rate SP value	50	DM510 displayed Rate (Rate Input)	80	Rate Output Slope	10.23
Rate SP value	50						
DM510 displayed Rate (Rate Input)	80						
Rate Output Slope	10.23						

Figure 23 – Rate Output Example calculation 1

Rate Input Example calculation 2:

Input channel specification:

The rate input voltage range is 0 to 10 VDC. Converting 4 –20 mA to voltage requires a 250ohm precision resistor for conversion to 1-5 VDC or a 500 ohm precision resistor for conversion to 2 –10 VDC. If 1 – 5 VDC is used see the Installation guide for setting the input range jumper on the I/O board.

The channel resolution is 10 bits. This equates to 10 volts being divided into 1024 steps.

<p>This situation is for systems where the DM510 displayed value is not a linear relationship or the speed control input is 2 – 10VDC or 4-20 mA. Note 500-ohm loop resistance is required to change the rate out signal to 4-20 mA. In these situations both the 'Rate Output Slope' and the 'Rate Output Offset' require adjustment.</p>	<p>To calculate the new slope:</p> <ol style="list-style-type: none"> To calculate the setpoint range 0 – 100% to provide a control output of 2 to 10 VDC. Resolution is 1024 bits / 10 volts = 102.4 bits per volt. Therefore: 2 volts = $102.4 * 2 = 204.8 = RawA$ 10 volts = $102.4 * 10 = 1024 = RawB$ 0% = RateSPA 100% = RateSPB To calculate the Rate Output Slope: $(RawB - RawA) / (RateSPB)$ To calculate the Rate Output Offset: $(RawA)$ Therefore: $(1024 - 204.8) / (100) = 8.192 = \text{new 'Rate Output Slope'}$ $204.8 = \text{new 'Rate Output Offset'}$
--	--

Figure 24 – Rate Output Example calculation 2

The system should be checked at one or two different settings and recalculated to move closer if required.

Note:

In determining the 'Rate Output Slope' and 'Rate Output Offset' ensure that the actual speed is never greater than the requested speed in the upper speed ranges. Similarly when requesting a speed in the lower ranges ensure that the actual speed is not lower than the requested speed. This ensures that when a speed is requested there is no overshooting or undershooting causing an alarm condition and possibly reverting to manual when running in Automatic at the limit.

The '**PID Control Loop**' can now be turned to the '**ON**' position to correct for minor setup discrepancies and subtle nonlinearities.

Moisture Calibration:

The moisture sensors are factory calibrated to perform over the designed range for both product moisture and product temperature. Changes by the installer are limited to adjusting the offset or bias to get the sensor initially to read closer to the bench top tester. Changes to the other parameters should only be made after consultation with the **Dryer Master Support Center**.

Select 'Moisture Calibration' to display the 'Moisture Calibration' screen.

- Press the '**arrow**' keys to highlight the selection. Type a new '**value**' followed by the '**Enter**' key.
- Press '**CANCEL**' to return the '**Installer Setup**' menu.

Moisture Calibration	
Inlet calibration bias (offset)	2.20
Inlet calibration gain (slope)	5.00
Inlet Temp compensation gain(slope)	0.00
Outlet 1 calibration bias (offset)	1.5
Outlet 1 calibration gain (slope)	5.00
Outlet 1 Temp compensation gain(slope)	0.00
Outlet 2 calibration bias (offset)	1.5
Outlet 2 calibration gain (slope)	5.00
Outlet 2 Temp compensation gain(slope)	0.00

Use ↑,↓ keys to highlight your choice.
Enter a new value, then press ENTER.
Press CANCEL to exit.

Figure 25- Settings (Installer Setup) Moisture Calibration Screen

Note:

*The calibration bias (offset) is described in the Supervisor Setup, Calibration description and the User's Guide. **The other settings should not be changed without explicit instruction from the Dryer Master Support Center.***

Dryer Volumes & Throughput:

The dryer's dimensions are critical to the operation of the DM510 Dryer Master control system. The DM510 Dryer Master requires accurate information with regard to the dryer holding volumes and throughput. Inaccurate values will reduce the effectiveness of your DM510 Dryer Master and may cause an out of control situation.

Steps to calibrating Volume & Throughput:

1. Measure and calculate the Dryer's Hot Zone and Cold Zone grain holding capacity.
2. Measure the Dryer's throughput.
3. Confirm capacities and throughput with the Dryer manufacturer's specifications.

Select '**Dryer Volumes & Throughput**' to display the '**Dryer Volumes & Throughput**' setup screen.

- Press the '**arrow**' keys to highlight the selection. Type a new '**value**' followed by the '**Enter**' key.
- Press '**CANCEL**' to return to the '**Installer Setup**' menu.

Volumes & Throughput	
Garner Size (see manual)	0.00
Hot Zone Size (drying zone)	200.0
Cold Zone Size (cooling zone)	100.0
Throughput Rate (see manual)	50.0
Dryer Dimensions are in	
0= Cubic Feet, 1= Bushels,	0
2= Cubic Meters, 3= Other,	
Use ↑,↓ keys to highlight your choice. Enter a new value, then press ENTER. Press CANCEL to exit.	

Figure 26 - Settings (Installer Setup) Volumes and throughput screen

Install the dryer volumes in any desired cubic measure. The following pages describe the dryer sections and how to determine throughput in detail.

Note: Dryer Volumes and Throughput are CRITICAL values for good control. Do Not guess. Calculate and double check.

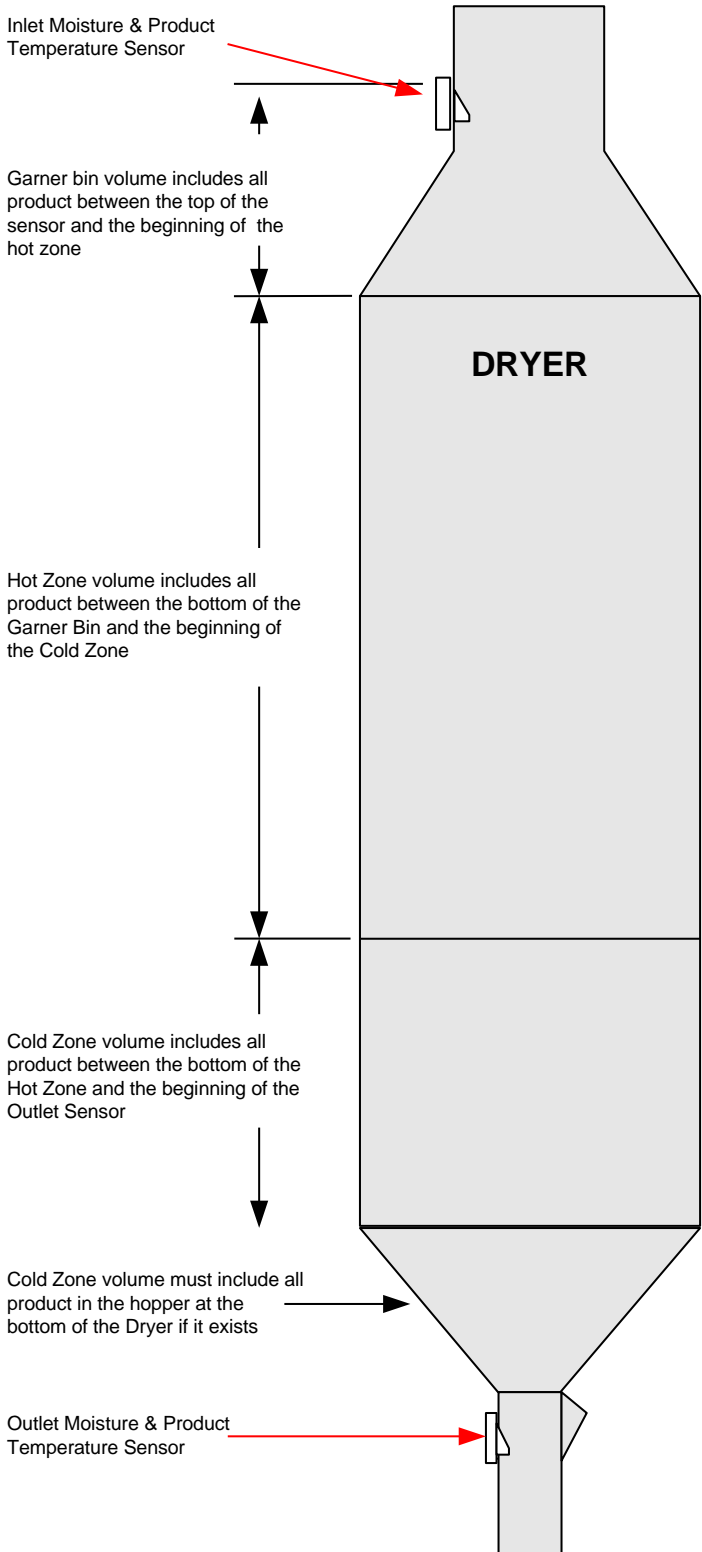

Figure 27 - Dryer Zones

Garner Bin Volume: Measure the volume of the garner bin from the top of inlet sensor to the top of the hot zone. DO NOT include the volume above the inlet sensor. Note that most round dryers (e.g.: Zimmerman, GSI) have little, if any, garner bin volume.

Hot Zone Volume: Measure or calculate the hot zone volume. This is the section around the hot air plenum. In systems with multiple burners and multiple hot zones include all zones and the transition sections. DO NOT include any portion that may have been included in garner bin calculations.

Cold Zone Volume: Measure or calculate the volume of the cold zone. Include the entire section between the hot zone and the outlet moisture sensor. If the outlet sensor is not directly at the bottom of the dryer, for example if it is at the end of a conveyor all product in the conveyor must be included in the Cold Zone Volume.

Note: If the dryer is drying all hot, there will be no cold zone volume. Therefore, the CZ volume should be set to 1% of Hot Zone volume.

Note:
It is possible to obtain the holding volumes (hot and cold zones) from the dryer manufacturer's specifications but ensure they are as specified by calculating and checking. The garner bin volume depends upon sensor placement.

Determining Dryer Throughput:

Before measuring the throughput of the dryer ensure that the discharge system has been calibrated.

You will need to calculate the **discharge/unload rate** that will empty the dryer in **1 hour**. Calculating this will involve measuring the volume of grain discharged over a period of time. The greater the volume and the longer the time will produce the more accurate result. This test should be performed at a typical unload speed as the unload volume is not linear over the total operating range of the dryer. It is possible to use the dryer manufacturer's specification.

Dryer Throughput example calculation:

<p>Fill the Dryer with dry product of the correct density and moisture and run the discharge at the typical operating speed for an hour or more or until the dryer is empty. Measure the volume of grain discharged.</p> <p>This example is in cubic feet, any cubic measure can be used as long as the same measure is used throughout.</p>	<p>To calculate the 'Throughput Rate':</p> <ol style="list-style-type: none"> 1) DM510 Dryer holding volume (Product between the moisture sensors) = Garner Size + Hot Zone Size + Cold Zone Size = 6000 cubic feet 2) Volume of grain discharged during test = 2000 cubic feet 3) Length of time test was run = 90 minutes. 4) Discharge speed as displayed by the DM510 = 48% 5) The formula for determining the 'Throughput Rate' = Dryer Holding Volume / (test volume / test time * 60) * discharge rate. 6) From the example numbers. 'Throughput Rate' = 6000 / (2000 / 90 * 60) * 48 = 216 <p>Therefore, at a throughput rate of '216' this dryer would empty in '1 hour'. Enter the calculated value as the 'Throughput Rate' value.</p>
---	--

Table 9 - Dryer throughput example calculation

If it is not possible to run a full throughput test, then enter a best estimate based on the Dryer manufacturer's specification and the operator experience. This is a good temporary value to begin with. It might also be possible for the Dryer Master Support Center to track inlet moisture changes through to the outlet and assist in determining a throughput. A few days of continuous operation with some inlet moisture variation is required for this to take place.

Note: Do not attempt Automatic operation without proper dryer volumes and a proven throughput. Less than optimum performance to downright total out of control operation can result.

Dryer Volumes and Throughput – Grain Handler dryers

There is a simple way to determine the dryer volumes and throughput for Grain Handler dryers, using the rule of thumb that each layer/tier has 52 bushels per tier, per 8 feet of dryer length. (**Note:** To simplify things there is also a chart of GrainHandler dryer volumes and throughputs for various models in Appendix 1.)

1. Determine the model number (e.g.: 2416 – which is 24 ft. long with 16 zones/tiers)
2. Determine how many hot zones and how many cooling zones
3. Use the formula (hot zones X length X 52/8) to get the hot zone volume
4. Use the formula (cooling zones X length X 52/8) to get cooling zone volumes
5. Add the numbers from 3 and 4 above to get the throughput value.

Example: Grain Handler Model 2416 dryer with 14 heating zones and 2 cooling zones

$$\begin{aligned} \text{Garner Bin (if sensor at bottom of garner bin)} &= 1 \text{ bushels} \\ \text{Hot Zone Volume} &= 14 \times 24 \times 52/8 = 2184 \text{ bushels} \\ \text{Cooling Zone Volume} &= 2 \times 24 \times 52/8 = \underline{312} \text{ bushels} \\ \text{Throughput Value (sum of volumes)} &= 2497 \text{ bushels} \end{aligned}$$

Note: It is very important to get the number of heating and cooling zones correct.

Note: Most mixed flow dryers can be set up in a similar fashion.

Moisture Sensor Setup:

Select 'Moisture Sensor Setup' to display the 'Moisture Sensor Setup' menu.

Note:

These settings should not be changed without explicit instruction from the Dryer Master Support Center.

- Press the **'arrow'** keys to highlight the selection. Type in a new **'Value'** followed by the **'Enter'** key
- Press **'Cancel'** to return to the **'Installer Setup'** menu

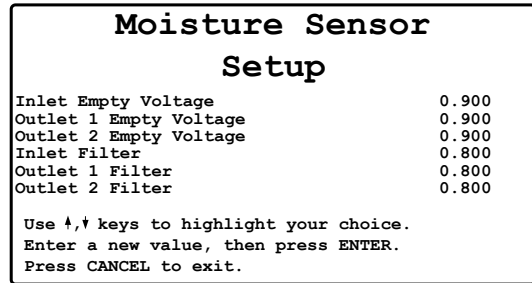

Figure 28 - Settings (Installer Setup) Moisture sensor setup screen

Inlet Empty Voltage Outlet 1 Empty Voltage Outlet 2 Empty Voltage	Signal level, at which the moisture sensor readings are considered too low to be valid as a moisture reading. The DM510 displays 'Empty' when the signal level drops below this value. The sensors minimum reading is between 0.5 and 0.75 volts.
Inlet Filter Outlet 1 Filter Outlet 2 Filter	The filter applied to the moisture signal to smooth out the displayed moisture reading. No filter is 0.0 and maximum filter is 0.99.

System Setup:

Select **'System Setup'** to display the **'System Setup'** menu.

- Press the **'number'** key to select the item.
Or
- Press the **'arrow'** keys to highlight the selection followed by the **'Enter'** key
- Press **'Cancel'** to return to the **'Installer setup'** screen

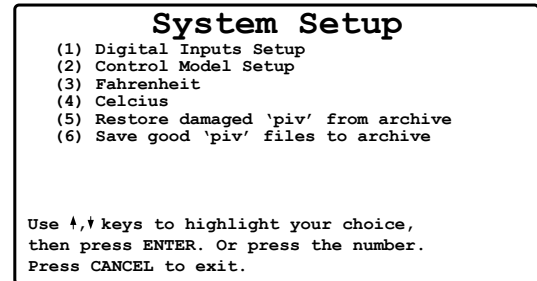

Figure 29 - Settings (Installer Setup) System setup menu

Digital Inputs Setup	See Select 'Digital Inputs Setup' to display the 'Digital Inputs Setup' menu
Control Model Setup	See Select 'Control Model Setup' to display the 'Control Model Setup' menu
Fahrenheit	Sets all temperatures and temperature alarms and limits to Factory default Fahrenheit values. Alarms and limits will need to be reviewed and reset as necessary
Celsius	Sets all temperatures and temperature alarms and limits to Factory default Celsius values. Alarms and limits will need to be reviewed and reset as necessary
Restore Damaged 'piv' from archive	Resets the 'piv' (Product Initialization Files) to factory default. This command is only used in the event that installer setup entries are not saved after a system power cycle. Should the system lose the installed settings it will be necessary to first restore the damaged files using this command before re-entering the values.
Save Good 'piv' files to archive	Installs the revised installer set up parameters as the system factory defaults. Note: The command (6) Save Good 'piv' files to archive' should not be attempted without explicit instructions from the Dryer Master support center. In the event that this command is executed with damaged setup files, the system will NOT be repairable without returning the system to Dryer Moisture Systems Inc. for repair.

Drying Temperature Setup:

Press 'Drying Temperature Setup' to display the 'Drying Temperature Setup' screen

- Press the 'arrow' keys to highlight the selection. Type in a new 'Value' followed by the 'Enter' key
- Press 'Cancel' to return to the 'Installer Setup' menu

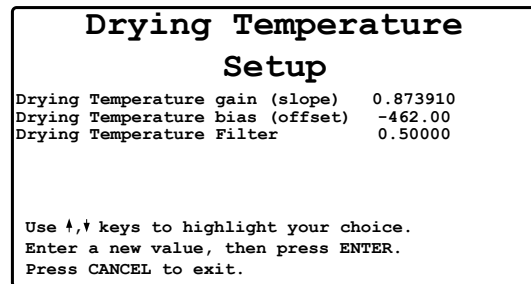

Figure 30 - Settings (Installer Setup) Temperature screen

Parameters are factory set for the signal converter typically supplied with the system. If you are using the APT sensor, you will need to input the correct values.

Default Values are:

	Signal	Converter	APT	Sensor
	°F	°C	°F	°C
Slope	0.5	.2777	0.87391	0.48828
Offset	-112	-80	-462	-273
Filter	0.5	0.5	0.5	0.5

To calculate the parameters for other sensor:

<p>This situation is for systems where the temperature signal is obtained from another source.</p> <p>Note: The Temperature input channel is configured for 0 -5 VDC input. Refer to the Installation manual for Jumper settings.</p>	<p>To calculate the new slope and offset:</p> <ol style="list-style-type: none"> To calculate the range for 1 to 5 VDC to display 0 – 300 °F <ol style="list-style-type: none"> Resolution is 1024 bits / 5 volts = 204.8 bits per volt. Therefore: 1 volts = 204.8 * 1 = 204.8 = RawA 5 volts = 204.8 * 5 = 1024 = RawB 0° = DisplayA 300° = DisplayB To calculate the Slope: <ol style="list-style-type: none"> (DisplayB - DisplayA) / (RawB - RawA) To calculate the Offset: <ol style="list-style-type: none"> DisplayA = RawA * Slope Therefore: <ol style="list-style-type: none"> (300 - 0) / (1024 - 204.8) = 0.366211 = new Slope (0 - 204.8) * 0.366211 = -75 = new Offset
---	---

Table 10 - Drying temperature setup example calculation

Equipment Setup check ...

At this point the system setup should now be completed. Use the checklist below to review the steps to ensure all tasks have been done.

It is also a good idea to record some of the key parameters in case you ever need to re-enter them.

There is a sheet to record parameters inside the door of the DM510. You can record the parameters there for safe storage, or on the rest of the page below.

In addition, if you make changes to your dryer or to your discharge system you should definitely review these numbers (most specifically dryer volumes, throughput rate and discharge rate set-up)

Setup check list

- Set System Date & Time
 Press **'Settings'** to display the **'Settings'** menu
 Select 'Set Date & Time' to display the 'Set Date & Time' screen

- Supervisor setup – Supervisor Setup, Control Limits:

Setup Completed for product	Corn	Beans	Wheat
Max Discharge Rate in Auto	_____	_____	_____
Min Discharge Rate in Auto	_____	_____	_____
Discharge Off Rate	_____	_____	_____
Burner Off Temperature	_____	_____	_____

Setup Completed for every product

- Supervisor setup – Supervisor Setup, Alarm Actions

Remote Alarm activation delay	_____	
Burner Shuts Off	NO	YES
Inlet is empty for 25 min.	NO	YES
Dryer Fans Shut Off	NO	YES

- Installer Setup – Discharge Rate setup

Rate Input Slope	_____
Rate Input Offset	_____

Rate Output Slope _____
 Rate Output Offset _____
 PID Control Loop ON OFF

Installer Setup – Dryer Volumes & Throughput:

Setup Completed for product	Corn	Bean	Wheat
Garner Size	_____	_____	_____
Hot Zone Size	_____	_____	_____
Cold Zone Size	_____	_____	_____
Throughput Rate	_____	_____	_____
Dryer Dimensions are in Feet ³ / Bushels / Meters ³			_____

Installer Setup –

Digital Input, Local/Remote Switch	Virtual	Real
Digital Input, Fan Status	Virtual	Real

Control Model, Moisture Model Difference _____
 Control Model, Moisture Target Difference _____

Installer Setup – Drying temperature setup

Drying Temperature gain (Slope) _____
 Drying Temperature bias (Offset) _____

Note:

The recorded values will serve, as a reference should re-entry of the parameters become necessary. **It should also be noted that any changes to the dryer, specifically changes to the discharge system will require recalculation of the following items:**

- Discharge Rate setup. Replacement or adjustment of the dryer’s discharge control.
- Throughput Rate. Changes or replacement of the unload system in the dryer. Specifically items involved in metering product out of the dryer.
- Adding holding capacity to a dryer will change the volumes and throughput.

Appendix 1: Dryer Volumes and Throughput for Grain Handler dryers

The chart below is for dryers post 2018. Starting in 2019, fan under Grain Handler dryers began using 3 cooling sections in all sizes of dryers. For conventional dryers, the number of cooling zones can be different. Previously smaller dryers had only 2 cooling zones.

If you have questions on the appropriate numbers for your dryer, contact the Dryer Master Support Center.

GrainHandler Volumes and Throughput						For Dryer Master DM510								
Assumes inlet sensor is at the bottom of the garner/top of the hot zone														
Always verify the number of heating and cooling zones on your dryer. Models may vary.														
Dryer		Zones		Hot Zone	Cold Zone	Throughput	Dryer		Zones		Hot Zone	Cold Zone	Throughput	
Model#	Hot	Cold	Size	Size		Model#	Hot	Cold	Size	Size				
8	10	8	3	364	156	520	32	10	7	3	1456	624	2080	
8	12	9	3	468	156	624	32	12	9	3	1872	624	2496	
8	16	13	3	676	156	832	32	14	11	3	2288	624	2912	
8	20	17	3	884	156	1040	32	16	13	3	2704	624	3328	
8	22	19	3	988	156	1144	32	18	15	3	3120	624	3744	
8	24	21	3	1092	156	1248	32	20	17	3	3536	624	4160	
8	26	23	3	1196	156	1352	32	22	19	3	3952	624	4576	
							32	24	21	3	4368	624	4992	
16	8	5	3	520	312	832	32	26	23	3	4784	624	5408	
16	10	7	3	728	312	1040								
16	12	9	3	936	312	1248	40	16	13	3	3380	780	4160	
16	14	11	3	1144	312	1456	40	18	15	3	3900	780	4680	
16	16	13	3	1352	312	1664	40	20	17	3	4420	780	5200	
16	18	15	3	1560	312	1872	40	22	19	3	4940	780	5720	
16	20	17	3	1768	312	2080	40	24	21	3	5460	780	6240	
16	22	19	3	1976	312	2288	40	26	23	3	5980	780	6760	
16	24	21	3	2184	312	2496								
16	26	23	3	2392	312	2704	48	16	13	3	4056	936	4992	
							48	18	15	3	4680	936	5616	
24	8	5	3	780	468	1248	48	20	17	3	5304	936	6240	
24	10	7	3	1092	468	1560	48	22	19	3	5928	936	6864	
24	12	9	3	1404	468	1872	48	24	21	3	6552	936	7488	
24	14	11	3	1716	468	2184	48	26	23	3	7176	936	8112	
24	16	13	3	2028	468	2496								
24	18	15	3	2340	468	2808	Note: Older (pre 2019) Grain Handler dryers							
24	20	17	3	2652	468	3120	may only have 2 cooling sections							
24	22	19	3	2964	468	3432	It is best to confirm if heat shields are besides or above the bur							
24	24	21	3	3276	468	3744	The burner does not move							
24	26	23	3	3588	468	4056	For questions call: 1-888-318-0009							

